

# AKZU Tracron M6 Track Lights

Product Data Sheet

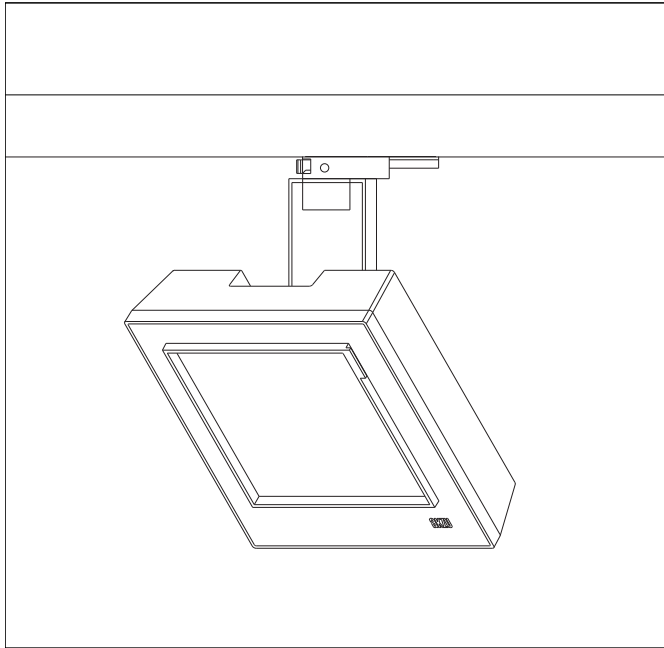

602275.000

### Technical Data

Light source: LED  
 Wattage: 40W  
 Voltage: 220-240VAC  
 Nominal luminous flux: 3900lm  
 Beam angle: 55°x19°, oval flood  
 Color temperature: 4000K, neutral white  
 Color Rendering Index: 90

### Technical Characteristics

Protection degree: IP20 (En60598)  
 Insulation class: Class I (En60598)

### Product Description

Housing and bracket: cast aluminium, powder-coated, Black, 0°- 90°tilt.  
 Bracket rotatable through 360°on 3-circuit adapter.  
 3-circuit adapter: plastic.  
 Including electronic control, dimmable with potentiometer for brightness control 0-100%.  
 Replaceable LED module: high-power LEDs on metal-core PCB, Collimating lens made of optical polymer.  
 Front cover: plastic.  
 Weight: 1.60kg

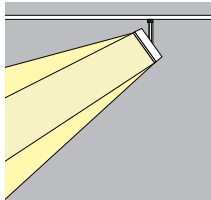

### Dimension

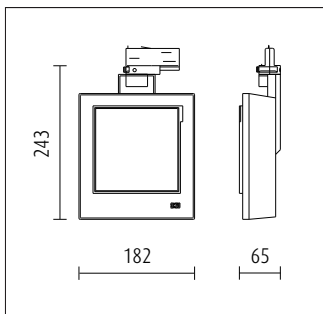

### Lighting Distribution Planning Data

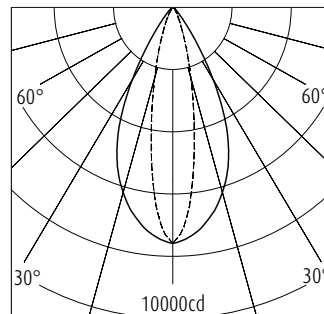

H(m)	D(m) C0	D(m) C90	E(lx)
2	1.99	0.76	1963
4	3.99	1.53	491
6	5.98	2.29	218
8	7.98	3.05	123
10	9.97	3.82	79

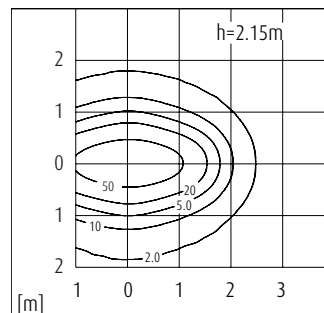

$\eta$ LOR=80%  
 UGR=15.7

E[lx]	100lx	500lx
a[m <sup>2</sup> ]	n=3	n=13
100		

All data, images, and specifications are for reference only and may be changed due to product improvement without prior notice.



3 circuit track



Surface mounted universal mono track point



Recessed mounted universal mono track point



Replaceable accessories principal lens



Anti-glare slides



Barn door

More details at [www.akzu.com/602275](http://www.akzu.com/602275)