

AKZU Tracron M6 Track Lights

Product Data Sheet

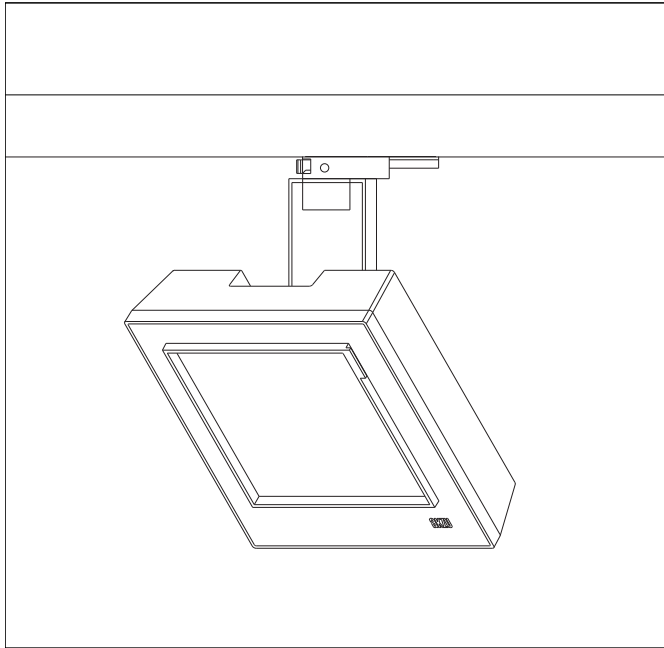

602274.000

Technical Data

Light source: LED
 Wattage: 40W
 Voltage: 220-240VAC
 Nominal luminous flux: 3900lm
 Beam angle: 55°x19°, oval flood
 Color temperature: 4000K, neutral white
 Color Rendering Index: 90

Technical Characteristics

Protection degree: IP20 (En60598)
 Insulation class: Class I (En60598)

Product Description

Housing and bracket: cast aluminium, powder-coated, White, 0°- 90°tilt.
 Bracket rotatable through 360°on 3-circuit adapter.
 3-circuit adapter: plastic.
 Including electronic control, dimmable with potentiometer for brightness control 0-100%.
 Replaceable LED module: high-power LEDs on metal-core PCB, Collimating lens made of optical polymer.
 Front cover: plastic.
 Weight: 1.60kg

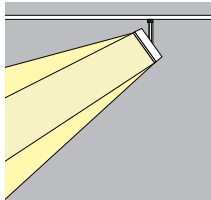

Dimension

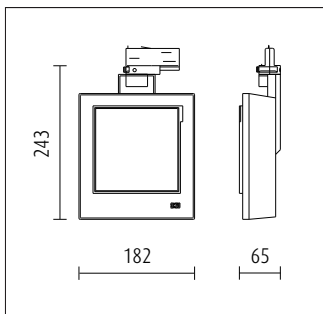

Lighting Distribution Planning Data

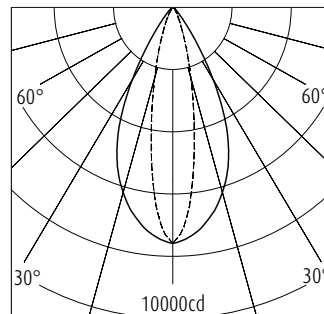

H(m)	D(m) C0	D(m) C90	E(lx)
2	1.99	0.76	1963
4	3.99	1.53	491
6	5.98	2.29	218
8	7.98	3.05	123
10	9.97	3.82	79

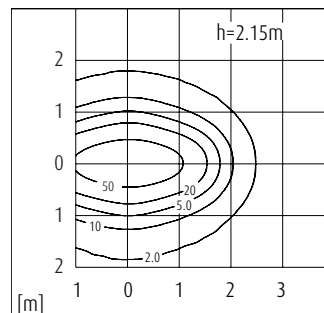

η LOR=80%
 UGR=15.7

E[lx]	100lx	500lx
a[m ²]	n=3	n=13
100		

All data, images, and specifications are for reference only and may be changed due to product improvement without prior notice.



3 circuit track



Surface mounted universal mono track point



Recessed mounted universal mono track point



Replaceable accessories principal lens



Anti-glare slides



Barn door

More details at www.akzu.com/602274