

# AKZU Tracron M6 Track Lights

Product Data Sheet

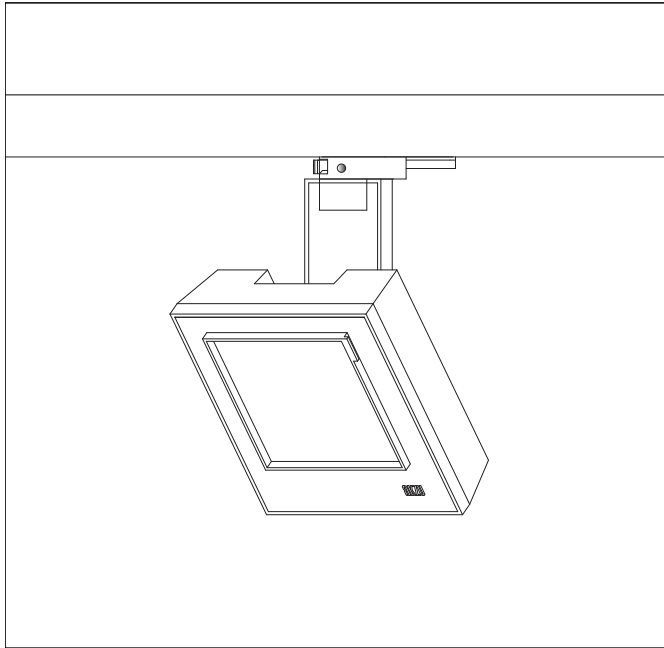

601894.000

### Technical Data

Light source: LED  
 Wattage: 12W  
 Voltage: 220-240VAC  
 Nominal luminous flux: 1040lm  
 Beam angle: 6°, direct spot  
 Color temperature: 4000K, neutral white  
 Color Rendering Index: 90

### Technical Characteristics

Protection degree: IP20 (En60598)  
 Insulation class: Class I (En60598)

### Product Description

Housing and bracket: cast aluminium, powder-coated, Black. 0°- 90°tilt.  
 Bracket rotatable through 360°on 3-circuit adapter.  
 3-circuit adapter: plastic.  
 Including electronic control, DALI Plug & Play.  
 Replaceable LED module: high-power LEDs on metal-core PCB, Collimating lens made of optical polymer.  
 Front cover: plastic.  
 Weight: 1.20kg

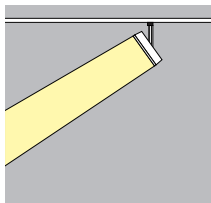

### Dimension

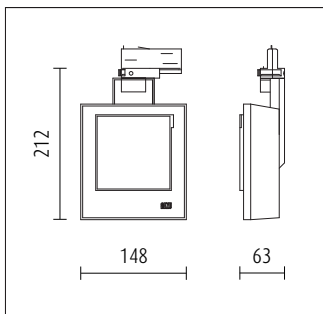

### Lighting Distribution Planning Data

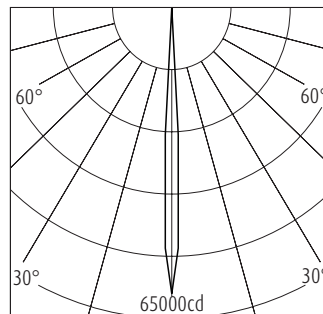

H(m)	D(m)	E(lx)
1	0.11	59555
2	0.22	14889
3	0.32	6617
4	0.43	3722
5	0.54	2382

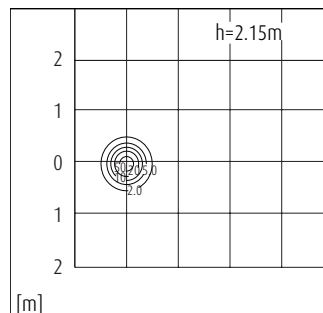

$\eta_{LOR}=80\%$   
 UGR=7.7

E[lx]	100lx	500lx
a[m <sup>2</sup> ]	n=12	n=60
100		

All data, images, and specifications are for reference only and may be changed due to product improvement without prior notice.



3 circuit track



Surface mounted universal mono track point



Recessed mounted universal mono track point



Replaceable accessories principal lens



Anti-glare slides



Barn door

More details at [www.akzu.com/601894](http://www.akzu.com/601894)