

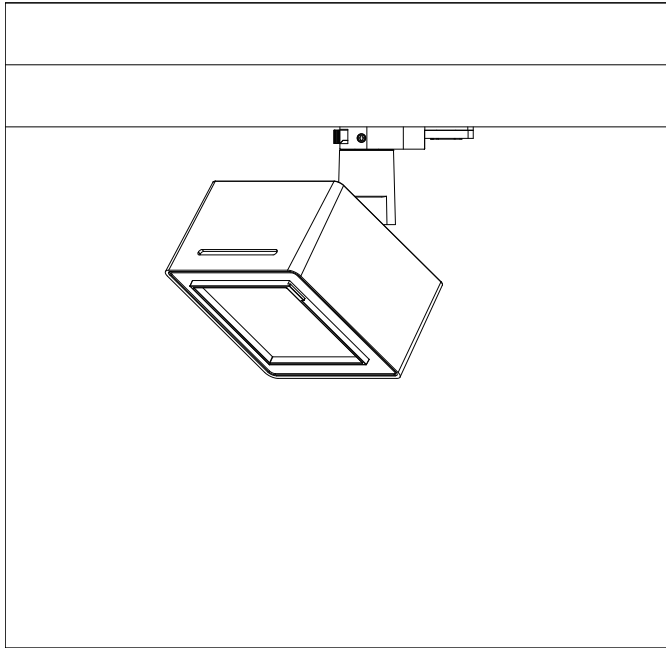

Tracron M4 Track Lights

Product Data Sheet

627659.000



Technical Data

Light source: LED
Wattage: 20W
Voltage: 220-240VAC
Nominal luminous flux: 1950lm
Beam angle: Wallwash
Color temperature: 4000K, neutral white
Color Rendering Index: 90

Technical Characteristics

Protection degree: IP20 (En60598)
Insulation class: Class I (En60598)

Product Description

Housing and bracket: cast aluminium, powder-coated, White. 0°- 90°tilt.
Bracket rotatable through 360°on 3-circuit adapter.
3-circuit adapter: plastic.
Including electronic control, DALI Plug & Play.
Replaceable LED module: high-power LEDs on metal-core PCB, Collimating lens made of optical polymer.
Front cover: plastic.
Weight: 1.10kg

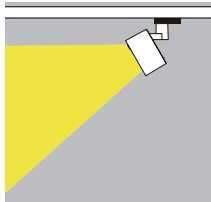

Dimension

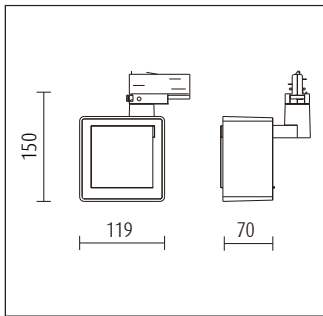

Lighting Distribution Planning Data

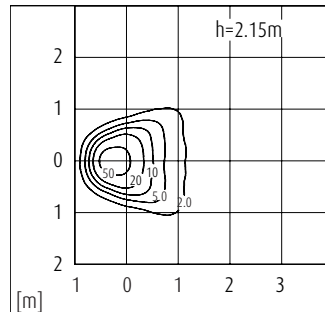
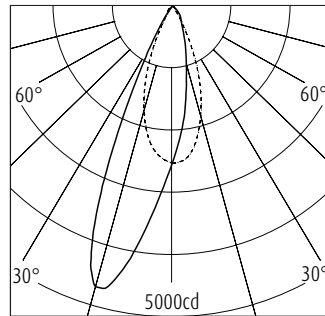

All data, images, and specifications are for reference only and may be changed due to product improvement without prior notice.



3 circuit track



Surface mounted universal mono track point



Recessed mounted universal mono track point



Replaceable accessories principal lens



Anti-glare slides



Barn door

More details at www.akzu.com/627659