

AKZU Tracron M4 Track Lights

Product Data Sheet



627519.000

Technical Data

Light source: LED
 Wattage: 20W
 Voltage: 220-240VAC
 Nominal luminous flux: 1950lm
 Beam angle: 16°, spot
 Color temperature: 4000K, neutral white
 Color Rendering Index: 90

Technical Characteristics

Protection degree: IP20 (En60598)
 Insulation class: Class I (En60598)

Product Description

Housing and bracket: cast aluminium, powder-coated, Black. 0°- 90°tilt.
 Bracket rotatable through 360°on 3-circuit adapter.
 3-circuit adapter: plastic.
 Including electronic control, DALI Plug & Play.
 Replaceable LED module: high-power LEDs on metal-core PCB, Collimating lens made of optical polymer.
 Front cover: plastic.
 Weight: 1.10kg

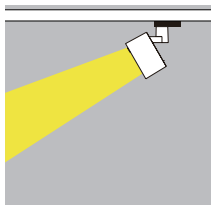

Dimension

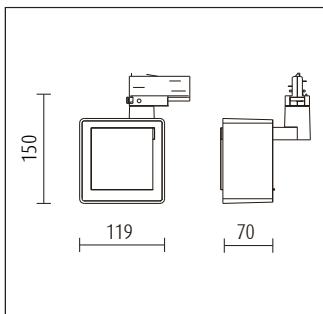

Lighting Distribution Planning Data

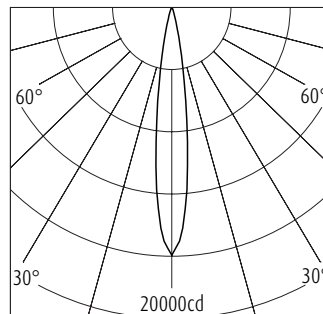

H(m)	D(m)	E(lx)
1	0.26	15928
2	0.52	3982
3	0.78	1770
4	1.04	996
5	1.30	637

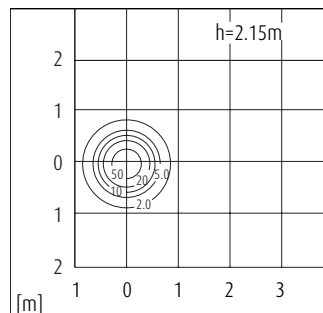

η LOR=80%
 UGR=14.2

E[lx]	100lx	500lx
a[m ²]	n=7	n=33
100		

All data, images, and specifications are for reference only and may be changed due to product improvement without prior notice.



3 circuit track



Surface mounted universal mono track point



Recessed mounted universal mono track point



Replaceable accessories principal lens



Anti-glare slides



Barn door

More details at www.akzu.com/627519