

AKZU Tracron M4 Track Lights

Product Data Sheet



627002.000

Technical Data

Light source: LED
 Wattage: 12W
 Voltage: 220-240VAC
 Nominal luminous flux: 920lm
 Beam angle: 6°, direct spot
 Color temperature: 3000K, warm white
 Color Rendering Index: 95

Technical Characteristics

Protection degree: IP20 (En60598)
 Insulation class: Class I (En60598)

Product Description

Housing and bracket: cast aluminium, powder-coated, Black. 0°- 90°tilt.
 Bracket rotatable through 360°on 3-circuit adapter.
 3-circuit adapter: plastic.
 Including electronic control, dimmable with potentiometer for brightness control 0-100%.
 Replaceable LED module: high-power LEDs on metal-core PCB, Collimating lens made of optical polymer.
 Front cover: plastic.
 Weight: 1.10kg

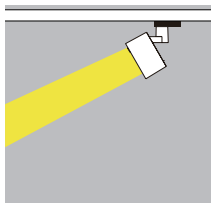

Dimension

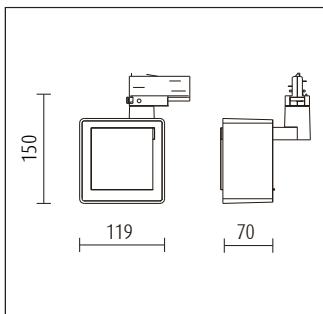

Lighting Distribution Planning Data

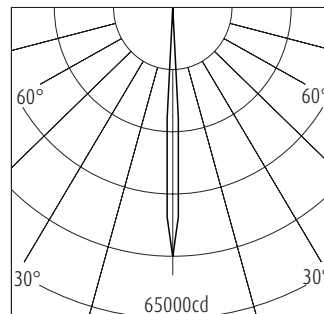

H(m)	D(m)	E(lx)
1	0.11	52110
2	0.22	13027
3	0.32	5790
4	0.43	3256
5	0.54	2084

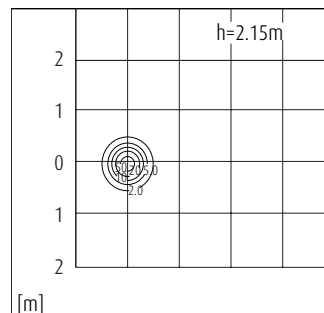

$\eta_{LOR}=80\%$
 $UGR=7.2$

E[lx]	100lx	500lx
a[m ²]	n=14	n=69
100		

All data, images, and specifications are for reference only and may be changed due to product improvement without prior notice.



3 circuit track



Surface mounted universal mono track point



Recessed mounted universal mono track point



Replaceable accessories principal lens



Anti-glare slides



Barn door

More details at www.akzu.com/627002