

# AKZU Tracron M3 Track Lights

Product Data Sheet



618895.000

### Technical Data

Light source: LED  
 Wattage: 12W  
 Voltage: 220-240VAC  
 Nominal luminous flux: 900lm  
 Beam angle: 55°x19°  
 Color temperature: 3000K, warm white  
 Color Rendering Index: 95

### Technical Characteristics

Protection degree: IP20 (En60598)  
 Insulation class: Class I (En60598)

### Product Description

Housing and bracket: cast aluminium, powder-coated, Black. 0°- 270°tilt.  
 Bracket rotatable through 360°on 3-circuit adapter.  
 3-circuit adapter: plastic.  
 Including electronic control, DALI Plug & Play.  
 Replaceable LED module: high-power LEDs on metal-core PCB, Collimating lens made of optical polymer.  
 Front cover: plastic.  
 Weight: 0.45kg

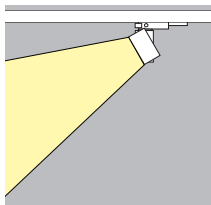

### Dimension



### Lighting Distribution Planning Data

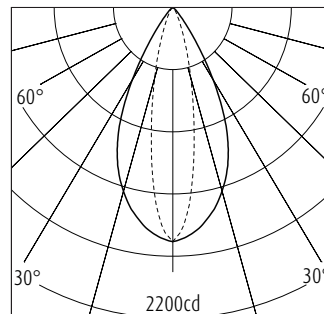

H(m)	D(m) C0	D(m) C90	E(lx)
1.0	1.00	0.38	1711
2.0	2.00	0.76	428
3.0	3.00	1.14	190
4.0	4.01	1.53	107
5.0	5.01	1.91	68

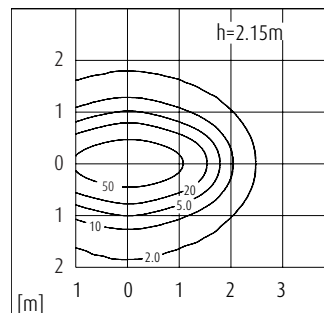

$\eta$ LOR=80%  
 UGR=14.6

E[lx]	100lx	500lx
a[m <sup>2</sup> ]	n=15	n=74
100		

All data, images, and specifications are for reference only and may be changed due to product improvement without prior notice.



3 circuit track



Surface mounted universal mono track point



Recessed mounted universal mono track point



Replaceable accessories principal lens

More details at [www.akzu.com/618895](http://www.akzu.com/618895)