

AKZU Tracron M3 Track Lights

Product Data Sheet



618207.000

Technical Data

Light source: LED
 Wattage: 12W
 Voltage: 220-240VAC
 Nominal luminous flux: 970lm
 Beam angle: 55°x19°
 Color temperature: 4000K, neutral white
 Color Rendering Index: 90

Technical Characteristics

Protection degree: IP20 (En60598)
 Insulation class: Class I (En60598)

Product Description

Housing and bracket: cast aluminium, powder-coated, Black. 0°- 270°tilt.
 Bracket rotatable through 360°on 3-circuit adapter.
 3-circuit adapter: plastic.
 Including electronic control, dimmable with potentiometer for brightness control 0-100%.
 Replaceable LED module: high-power LEDs on metal-core PCB, Collimating lens made of optical polymer.
 Front cover: plastic.
 Weight: 0.45kg

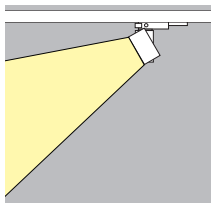

Dimension



Lighting Distribution Planning Data

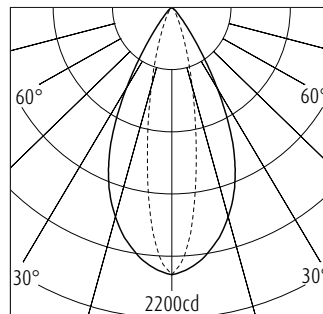

H(m)	D(m) C0	D(m) C90	E(lx)
1.0	1.00	0.38	1953
2.0	2.00	0.76	488
3.0	3.00	1.14	217
4.0	4.01	1.53	122
5.0	5.01	1.91	78

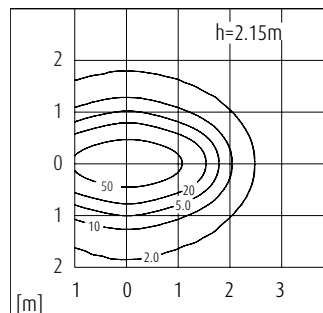

η LOR=80%
 UGR=15.7

E[lx]	100lx	500lx
a[m ²]	n=13	n=65
100		

All data, images, and specifications are for reference only and may be changed due to product improvement without prior notice.



3 circuit track



Surface mounted universal mono track point



Recessed mounted universal mono track point



Replaceable accessories principal lens

More details at www.akzu.com/618207