

812202.030

Technical Data

Light source: LED
 Wattage: 2W
 Voltage: 3VDC (series circuit), 12/24VDC (parallel circuit)
 Nominal luminous flux: 160lm
 Beam angle: 55°x19°, oval flood
 Color temperature: 3000K, warm white
 Color Rendering Index: 95

Technical Characteristics

Protection degree: IP20 (En60598)
 Insulation class: Class III (En60598)

Product Description

Housing and rear cover: anodised aluminium, black, 0° - 90° tilt.
 Bracket: anodised aluminium, with permanent magnets for easy installation, black.
 Spherulit lens and collimating lens system made of optical polymer, directs the light precisely and without loss.

Lightsystem

DALI, with dimmer are alternative.
 High performance electronic control gear to be ordered separately.
 Weight: 0.10kg

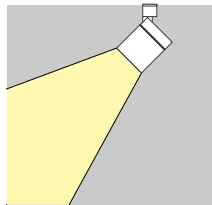

Dimension

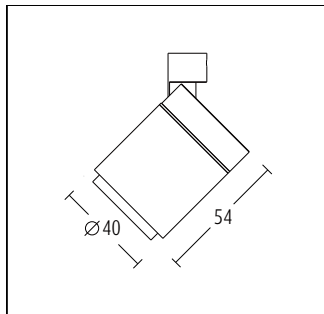

Lighting Distribution Planning Data

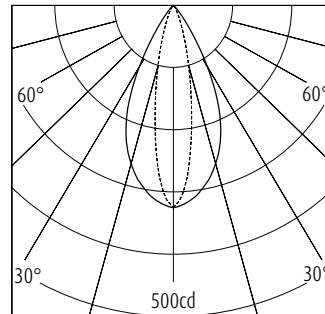

H(m)	D(m) C0	D(m) C90	E(lx)
0.5	0.50	0.19	1295
1.0	1.00	0.38	324
1.5	1.50	0.57	143
2.0	2.00	0.76	81
2.5	2.50	0.95	52

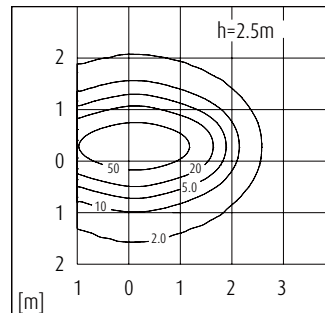

$\eta_{LOR}=80\%$
 UGR=12.0

E[lx]	100lx	500lx
a[m ²]	n=1	n=4
1		

Mounting

All data, images, and specifications are for reference only and may be changed due to product improvement without prior notice.

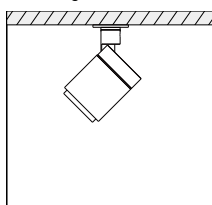

Surface mounting

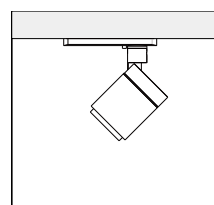

Track mounting

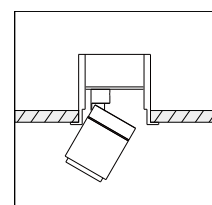

Recessed mounting

More details at www.akzu.com/812202