

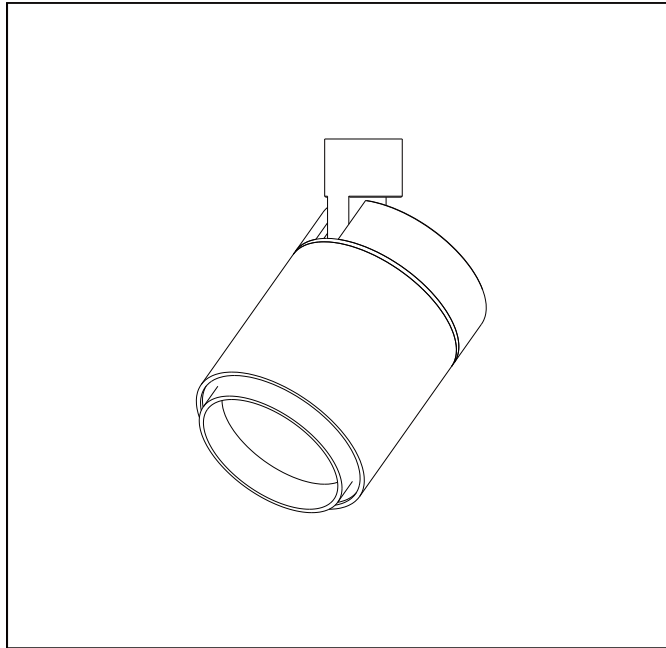

Sprite X2 Cabinet Light

Product Data Sheet



812066.030

Technical Data

Light source: LED
Wattage: 2W
Voltage: 3VDC (series circuit), 12/24VDC (parallel circuit)
Nominal luminous flux: 220lm
Beam angle: 6°-29°, zoom
Color temperature: 4000K, neutral white
Color Rendering Index: 85

Technical Characteristics

Protection degree: IP20 (En60598)
Insulation class: Class III (En60598)

Product Description

Housing and rear cover: anodised aluminium, black, 0° - 90° tilt.
Bracket: anodised aluminium, with permanent magnets for easy installation, black.
Spherulit lens and collimating lens system made of optical polymer, directs the light precisely and without loss.

Lightsystem

DALI, with dimmer are alternative.
High performance electronic control gear to be ordered separately.
Weight: 0.10kg

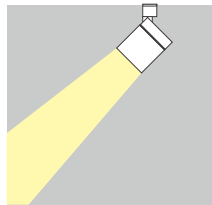

Dimension

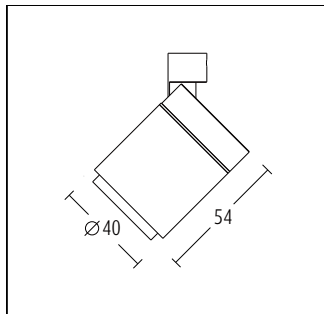

Lighting Distribution Planning Data

6°		
H(m)	D(m)	E(lx)
0.5	0,05	50395
1.0	0,11	12599
1.5	0,16	5599
2.0	0,22	3150
2.5	0,27	2016

29°		
H(m)	D(m)	E(lx)
0.5	0,11	2708
1.0	0,21	677
1.5	0,32	300
2.0	0,42	170
2.5	0,53	109

All data, images, and specifications are for reference only and may be changed due to product improvement without prior notice.

Mounting

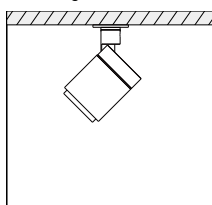

Surface mounting

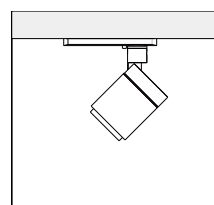

Track mounting

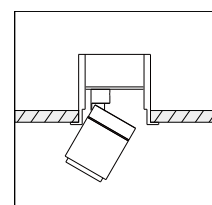

Recessed mounting

More details at www.akzu.com/812066