

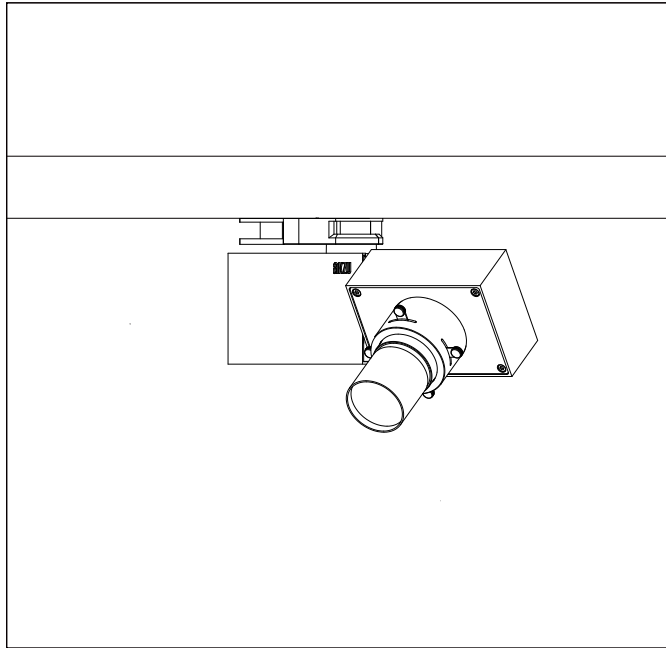

# DUX A3 Framing Projector

Product Data Sheet

664029.000



### Technical Data

Light source: LED  
 Wattage: 12W  
 Voltage: 220-240VAC  
 Nominal luminous flux: 1240lm  
 Beam angle: max 36°  
 Color temperature: 3000K, warm white  
 Color Rendering Index: 95  
 SDCM: <2

### Technical Characteristics

Protection degree: IP20 (EN60598)  
 Insulation class: Class I (EN60598)

### Production Description

Housing and bracket: cast aluminium, powder-coated, black. 0°- 270° tilt.  
 Bracket rotatable through 360° on 3-circuit adapter.  
 3-circuit adapter: plastic.  
 Including electronic control, DALI Plug & Play.  
 Replaceable LED module: chip on board.  
 Weight: 0.70kg

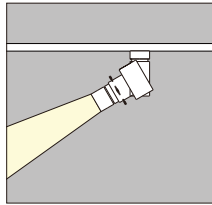

### Dimension

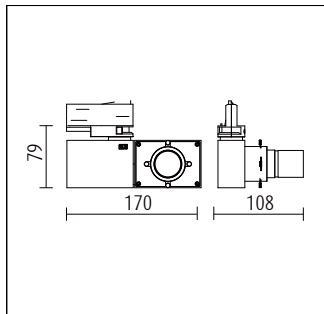

### Lighting Distribution Planning Data

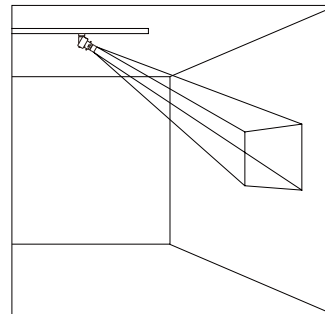

H(m)	D(m)	E(lx)
1.0	0.46	219
1.5	0.68	96
2.0	0.92	54
2.5	1.15	34
3.0	1.37	24

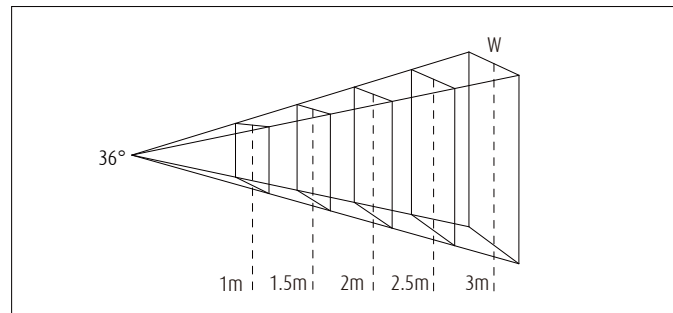

All data, images, and specifications are for reference only and may be changed due to product improvement without prior notice.

More details at [www.akzu.com/664029](http://www.akzu.com/664029)

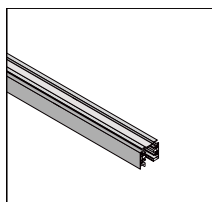

3 circuit track

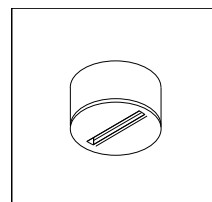

Surface mounted universal mono track point

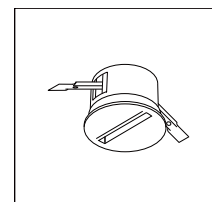

Recessed mounted universal mono track point