

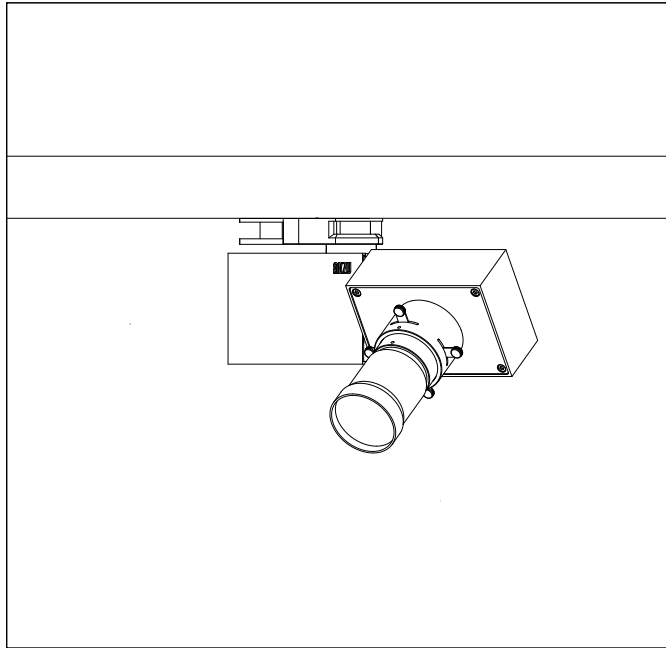

DUX A3 Framing Projector

Product Data Sheet

664002.000



Technical Data

Light source: LED
 Wattage: 14W
 Voltage: 220-240VAC
 Nominal luminous flux: 1240lm
 Beam angle: max 12°
 Color temperature: 3000K, warm white
 Color Rendering Index: 95
 SDCM: <2

Technical Characteristics

Protection degree: IP20 (EN60598)
 Insulation class: Class I (EN60598)

Production Description

Housing and bracket: cast aluminium, powder-coated, black. 0°- 270° tilt.
 Bracket rotatable through 360° on 3-circuit adapter.
 3-circuit adapter: plastic.
 Including electronic control, dimmable with potentiometer for brightness control 0-100%.
 Replaceable LED module: chip on board.
 Weight: 0.70kg

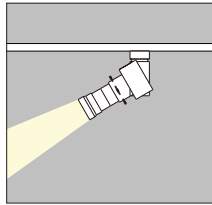

Dimension

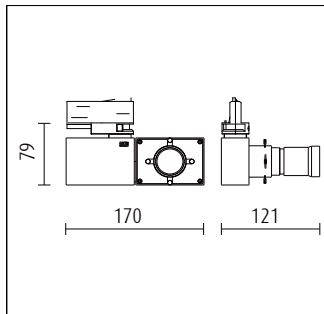

Lighting Distribution Planning Data

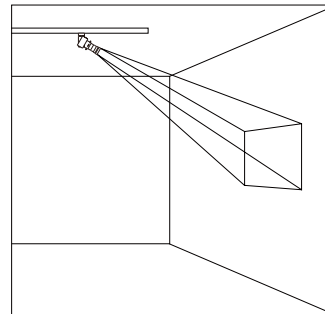

H(m)	D(m)	E(lx)
1.0	0.14	865
1.5	0.22	384
2.0	0.31	216
2.5	0.39	138
3.0	0.48	96

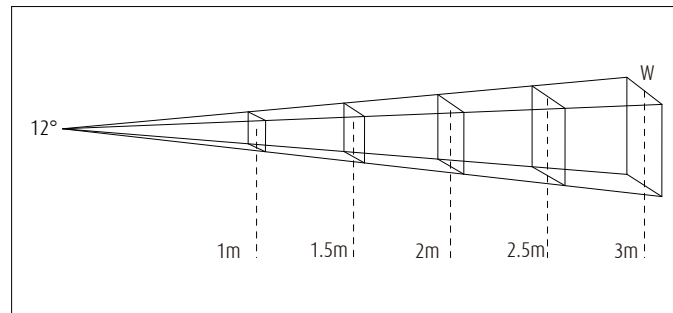

All data, images, and specifications are for reference only and may be changed due to product improvement without prior notice.

More details at www.akzu.com/664002

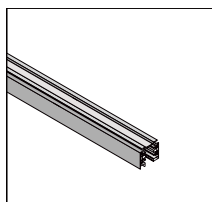

3 circuit track

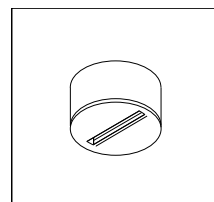

Surface mounted universal mono track point

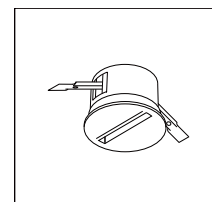

Recessed mounted universal mono track point